



THALASSA 900XGWH
Cod. **02159006** EAN **8422248104821**

Touch Control Panel with digital display, automatic shut-down timer and cleaning filters indicator

AUTO connectivity with automatic control from the CATA hob

6 extraction levels, 5 + 1 **TURBO**

Extraction power (according to UNE/EN 61591): **825m³/h** - 200m³/h

Motor maximum airflow free outlet: **1400m³/h**

Sound power (Reg.(EU) n°65/2014): 40dB(A), maximum: 64dB(A)

BRUSHLESS motor. Ultra silent. Maximum energy consumption **135W**

High-efficiency lighting by intensity-adjustable two-tone warm / natural LED STRIP

Easy-to-install system

Non-condensation filter and Filter condensation collection area

Dishwasher-washable filters

White glass finishing

Max. Pressure: 357 Pa

150/125 mm outlet diameter

Energy Class: A+++

Accessories (not included)

Active charcoal filter	Cod. 02859318 / EAN 8422248098472
Check valve	Cod. 02832008 / EAN 8422248086837
Top tub BK	Cod. 02861403 / EAN 8422248078818
Top tub WH	Cod. 02861003 / EAN 8422248097765
Top tub INOX	Cod. 02861303 / EAN 8422248097758

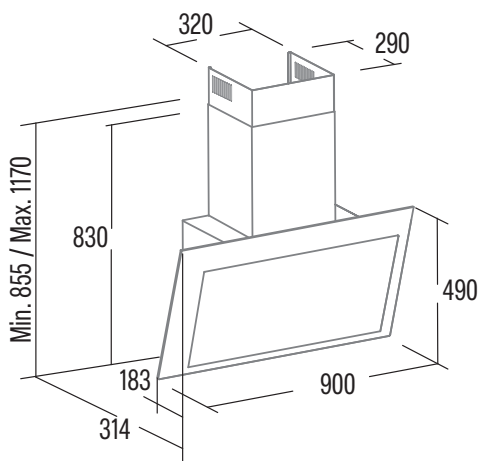

Code	02159006
EAN	8422248104821
Model	THALASSA 900XGWH /F
Type	Vertical
Product fiche according to directives EU65/2014 - EN61591, EN60704-2-13, EN50564	
AEC (Annual Energy consumption) (kWh/annum)	14,5
EEL class (Energy Efficiency Class)	A+++
FDE (Fluid Dynamic Efficiency)	39,7
FDE class (Fluid Dynamic Efficiency Class)	A
LE (Lighting Efficiency) (lux/W)	26,3
LE class (Lighting Efficiency Class)	B
GFE (Grease Filtering Efficiency)	75,5
GFE Class (Grease Filtering Efficiency class)	C
Air flow at minimum speed (m ³ /h)	200
Air flow at maximum speed (m ³ /h)	605
Air flow at intensive speed (TURBO) (m ³ /h)	825
Sound Power Level at minimum speed (dB)	40
Sound Power Level at maximum speed (dB)	64
Sound Power Level at intensive speed (TURBO) (dB)	69
Po (Power Consumption in off mode) (W)	0,4
Ps (Power Consumption in standby) (W)	0
Integration directive EU 66/2014	
f (Time Increase Factor)	0,6
EEL (Energy Efficiency Index)	29,3
QBEP (Flow Rate at Best Efficiency Point) (m ³ /h)	259,7
PBEP (Static Pressure Difference at Best Efficiency Point) (Pa)	326,2
WBEP (Electric Power Input at Best Efficiency Point) (W)	59,2
WL (Nominal Power Consumption of Lighting system) (W)	3
EMIDDLE (Average Illumination of Lighting system on Cooking surface) (lux)	79
External Dimensions	
Width (mm)	900
Depth (mm)	314
Total max height(mm)	1170
Total min height(mm)	855
Outlet Diameter (mm)	150/125
Characteristics	
Motor	BT4DC
Extraction Levels	5 + 1
Motor Maximum Power Consumption	140
Maximum Pressure	357
Intensive Speed (TURBO) Pressure	365
Control Type	TCD6i
Automatic shut-down timer	√
Electronic Filter Saturation Indicator	√
Filter Type	Metallic
Anti-grease Filter Number	2+1
Inner Shield	-
Lighting	
Light Type	SS Led
Adjustable Intensity Lighting	√
Nº of Lamps	1
Installation	
Minimum height distance to a electric worktop hob (mm)	400
Minimum height distance to a gas worktop hob (mm)	650
Installation with Outlet tube to the exterior / Recirculating	BOTH
Easy Installation System	√
Electric Connection	
Total Rush Power (W)	143
Rated Voltage (V)	220-240
Network Frequency (Hz)	50
Electrical Insulation Class	CLASS I
Plug	-
Accessories	
Upper Decorative tube Extension	02861300
White Decorative Tube	02861001
Black Decorative Tube	-
Island Tube Enhancer	-
Check Valve	02832004
MAX PRO Metal Filter	-
Metal Filter	02800905 / 02800925*
DUAL Filter (metal + active charcoal)	02800918 / 02800927
Active Charcoal Filter	02859318
Noiseless Flexible Duct	02893002